

ORIGINAL INSTRUCTIONS

OPERATING & MAINTENANCE MANUAL



SPACE HEATERS

dc17, dc30, dc50

*Diesel/Kerosene Direct Fired Space
Heater*

Not for domestic use - Space Heating Only

Made in Korea for:

Spitwater Australia Pty Ltd T/A Ottico Equipment

953 Metry Street, Albury NSW 2640 Australia

spitwater.com.au



CREATORS OF

SPITWATER



WARNING: Read and understand this instruction manual before operating this unit and retain for future reference. Failure to follow operating, safety and maintenance instructions outlined in this manual releases the manufacturer from any responsibility for any accidents or damage incurred and may render any warranty void.

TECHNICAL DATA					
	PRODUCT	HEATER			UNIT
	MODEL	DC17	DC30	DC50	
PERFORMANCE					
	HEAT OUTPUT	17	30	50	kW
	PUMP PRESSURE	0.21	0.28	0.48	BAR
	FUEL CONSUMPTION	1.37	2.4	4.12	Kg/H
	MINIMUM ROOM VOLUME	145	250	450	M ³
FUEL					
	FUEL SUPPLY	Diesel Kerosene	Diesel Kerosene	Diesel Kerosene	
	FUEL TANK CAPACITY	19	38	49	L
ELECTRICAL					
	ELECTRICAL SUPPLY	230/1/50	230/1/50	230/1/50	V~/Hz
	CONNECTED LOAD	140	190	280	W
DIMENSION & WEIGHT					
	LENGTH	810	918	1062	mm
	WIDTH	300	547	587	mm
	HEIGHT	420	625	664	mm
	WEIGHT (without fuel)	12.0	24.0	48.0	Kg

Date of purchase	
Business name	
Address	
Phone number	

The manufacturer reserves the right to modify designs, features and technical data without notice.

INTRODUCTION

The JETFIRE range of portable heaters are designed to give safe, efficient and reliable service when the correct operating sequence are followed and proper attention is given to cleaning and maintenance procedures. This manual is to provide up to date information necessary to the user for operating, cleaning and servicing the heaters, together with fault-finding techniques and general specifications, details and diagrams. Please note that the information given herein after may be subject to revision in compliance with the policy of continual improvements.

The JETFIRE range of heaters should only be used in the manner and purpose for which they were intended and in accordance with the recommendations and safety precautions detailed in this manual and in operating instructions and stickers on the unit itself.

All JETFIRE heaters undergo rigorous safety and operational tests before being despatched into the marketplace however it is still imperative that prior to used, all operators have read and understood all information and instructions provided and are aware of possible hazards.

GENERAL DESCRIPTION & INTENDED USE

The booklet contains important information for the use and safe operation of this heater. Please read and all warnings before you start using the unit.



SPARE PARTS AND ACCESSORIES

Spitwater has an extensive range of spare parts and accessories to suit all your heating needs.



For spare parts and service please contact **1800 SPITWATER**

To view our extensive range of industrial heaters visit www.spitwater.com.au

The following symbols are used throughout this instruction booklet in order to mark important paragraphs or sections that are due particular attention. Their meaning is listed next to them for your attention.

	WARNING Failure to follow instruction could result in injury or death		WARNING Failure to follow instruction could result in damage to machine		These are tips and instructions to ensure safe and proper operation
--	---	---	---	---	---

The following symbols are used on the machine in order to warn user of potential injury if not cautious. Their meaning is listed next to them for your attention.





	WARNING Hot surface Do not touch, will result in injury		WARNING Electric shock Disconnect power before removing cover		
--	--	---	--	--	--





IMPORTANT SAFETY INSTRUCTIONS AND PRECAUTIONS

WARNING: This heater shall only be used by persons instructed in its use that have been expressly authorized to do so. Before using this heater please pay particular attention to the following safety warnings as failure to do so could result in serious injury.

GENERAL WARNING



- 1  Make sure you have read and understood the whole instruction manual before installing, operating or carrying out any maintenance on the unit.
- 2  Warnings and data plates on the machine provide important directions and information on the safe use of the unit.
- 3  Besides these operating and safety instructions please make sure that all accident prevention regulations applicable in the country of use are followed.
- 4  As well as these operating and safety instructions any standards relating to the installation and operation of industrial heaters applicable in your country must be strictly followed.

TRANSPORT





















- 1  For safe moving of the unit between work areas make sure that the unit has been switched off and is allowed to cool if necessary.
- 2  Lift from handle of the machine.
- 3  For safe transport in and on vehicles make sure the machine is appropriately strapped in order to avoid it sliding or falling.

SAFETY INSTRUCTIONS & PRECAUTIONS



1 GENERAL

-  - The heater unit must be positioned on flat stable ground and must be in an upright position before operating. Do not operate on uneven surface or loose gravel.
-  - The heater unit must be checked that it is safe and in proper working order before putting into service and before every use. If the unit is damaged do not use it.
-  - The heating space must be properly ventilated in compliance with this manual and the heater unit must be serviced as per maintenance guidelines in this manual to avoid carbon monoxide build up, which can lead to death.

2 WHILE USING THE HEATER

-  - Read all instructions before using this heater take care to ensure you fully understand the instructions concerning electricity and fuel supply.
-  - Know how to start and stop the unit. Be quite familiar with the controls.
-  - Allow a minimum room size as listed in the technical specifications.
-  - Not for domestic use, space heating only.
-  - Local regulations should be followed as to the installation of industrial heaters.
-  - Do not operate the heater if it is damaged.
-  - Never leave the heater unattended whilst running.
-  - Permanent ventilation to the outside atmosphere must be provided. Allow 96 sq.cm for every 1000W input divided equally between floor and high levels.
-  - Do not operate this heater in basements or below ground.
-  - Do not restrict under any circumstances either the inlet or outlet end of the heater.
-  - The heater must not be used in close proximity to combustible or flammable materials.
-  - The heater must operate in a space with clearance of 1m above and behind and 600mm on the sides. A guard must be placed 900mm away from the heater outlet to prevent the approach of combustible materials.
-  - Always use the handle to move the heater after it has been operating as other parts of the heater may be very hot.
-  - Use only clean filtered diesel or kerosene as fuel. Do not refill the fuel tank while the heater is running or is still hot.
-  - Follow the maintenance procedures and fault-finding techniques outlined in the manual.
-  - To prevent injury always disconnect the power plug before disassembling any part of the heater.
-  - Do not carry out temporary repairs on worn or damaged electrical cords and plugs.
-  - Have worn, cut or damaged cords and plugs replaced by an authorised service person or electrician.
-  - Do not pull on the electrical cord in order to unplug the unit.
-  - Do not use this heater in the rain or when it is at risk of being sprayed with water.

3 ELECTRICITY SUPPLY

-  - The JETFIRE range of heaters is designed to run off 230V Single-Phase 50Hz electrical supply. The unit should be plugged into a 10A outlet.
-  - The appliances must be earthed.
-  - If the Plug needs to be replaced to suit local requirements a qualified electrician should carry out the replacement taking care to earth the unit and maintain the correct phase connection as per the wiring diagram.

4 FUEL SUPPLY

-  - Please only use the following fuel types in the heater:
Kerosene with viscosity of 1.3 cSt or Diesel with viscosity of 1.5 cSt.

SAFETY DEVICES

Temperature Limit Control :

This heater is equipped with a Temperature Limit Control designed to turn off the heater should the internal temperature rise to an unsafe level. If this device activates and turns your heater off it may require service.

(Internal Shut-Off Temperature - 212°F/100°C ± 10°, Reset Temperature - 176°F/80°C ± 10°)

MODEL	Internal Shut-off Temp. ± 10°	Reset Temperature ± 10°
DC17	176°F/80°C	122°F/50°C
DC30	230°F/110°C	194°F/90°C
DC50	194°F/90°C	140°F/60°C









Electrical System Protection :

The heater's electrical system is protected by a fuse mounted to the PCB assembly that protects the system components from damage. If the heater fails, check the fuse first, and replace if necessary. (Fuse type - 250 Volts / 5 AMPS for all models)

Flame-Out Sensor

The heater uses photocell to see the flame in the combustion chamber. Should the flame extinguish, the sensor will stop electrical current and the heater will shut off.

MAINTENANCE & SERVICING

-  Carry out all regular maintenance and inspections as listed in this manual using original JETFIRE parts where required.
-  Always make sure before carrying out any maintenance that the unit is turned off and allowed to cool down.
-  Always make sure to disconnect the power plug from the mains outlet before carrying out any maintenance work on the unit.
-  Never carry out any maintenance work not expressly outlined in this booklet and never make any technical modifications to this unit.
-  This unit is fitted with safety devices which are set and sealed at the factory. It is very important these devices receive their routine maintenance to assure your safety as well as necessary protection of the unit.
-  There are a number of very important components that have been set and sealed at the factory. Never under any circumstances tamper with, modify or adjust these settings.
-  Make sure this unit is regularly serviced by an authorized JETFIRE agent according to the servicing requirement outlined in this booklet.
-  Always dispose of unused fuel according to requirements of the local authorities.



OPERATING ELEMENTS

Please see operating elements below to help familiarize yourself with the components of this unit.

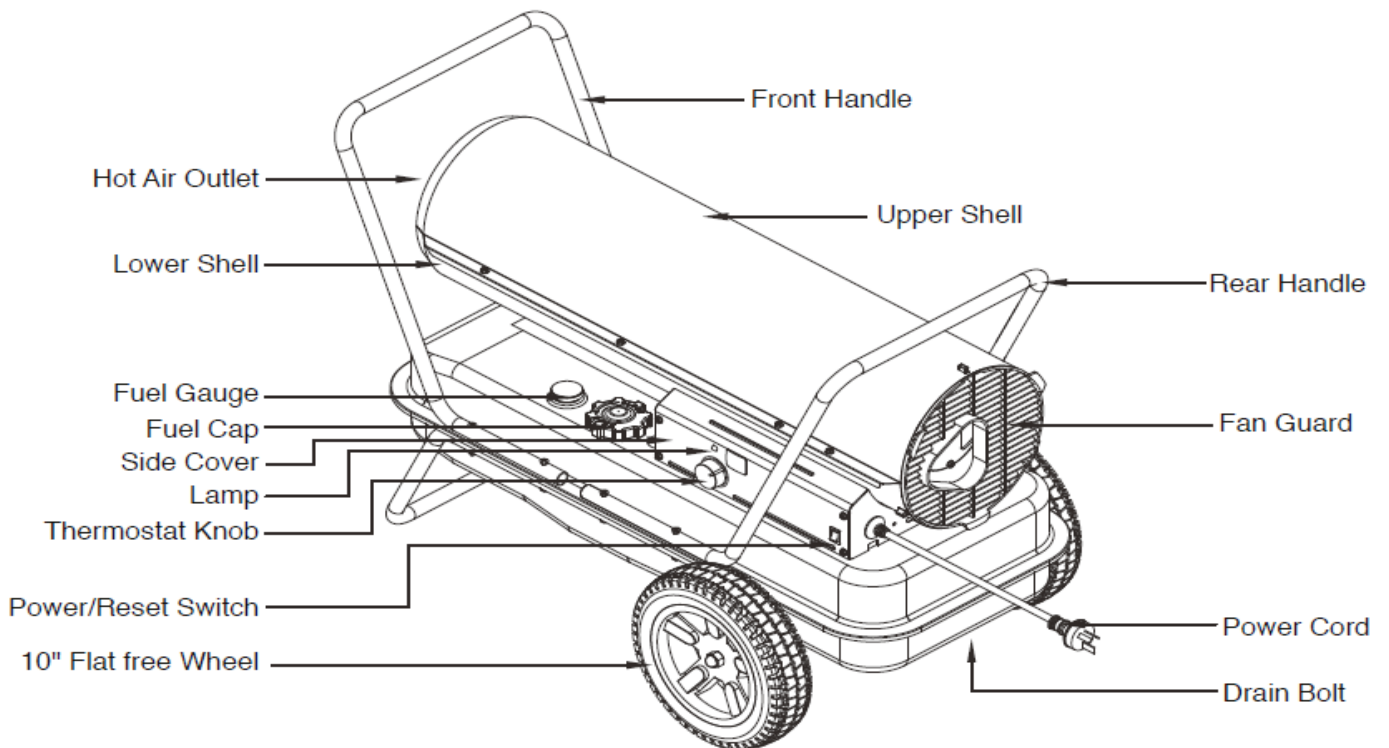
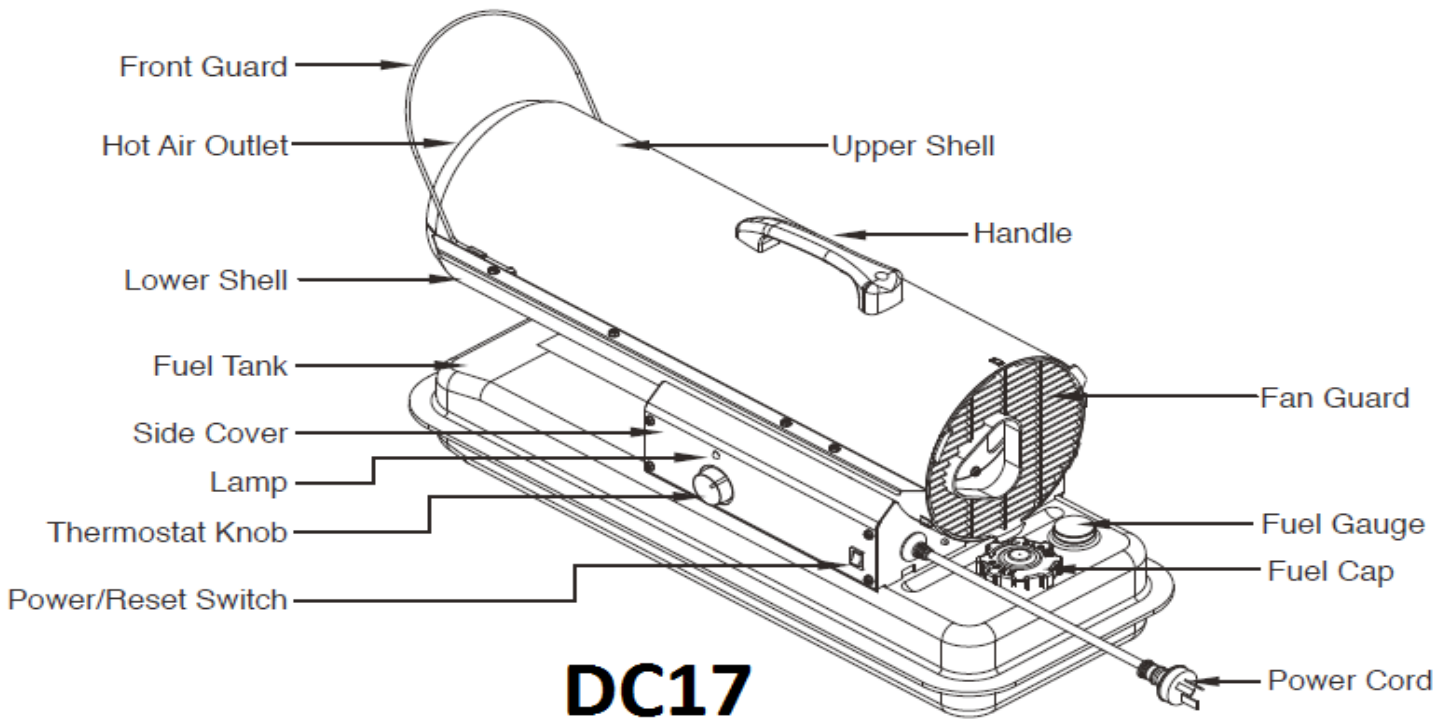

Figure A

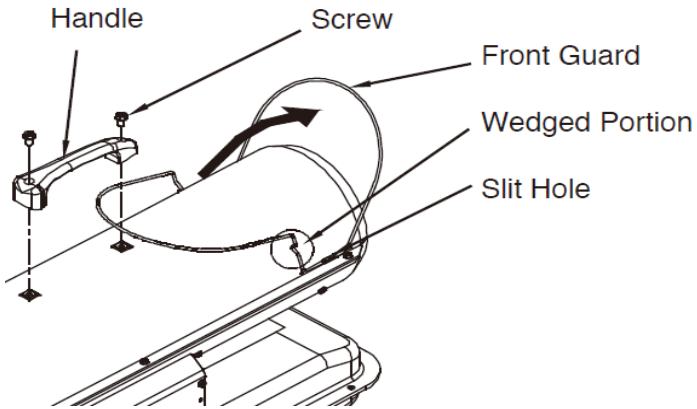

Figure E

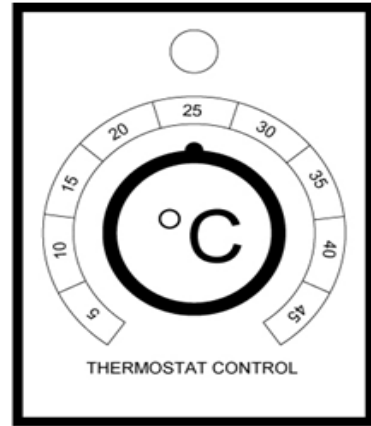

Figure B

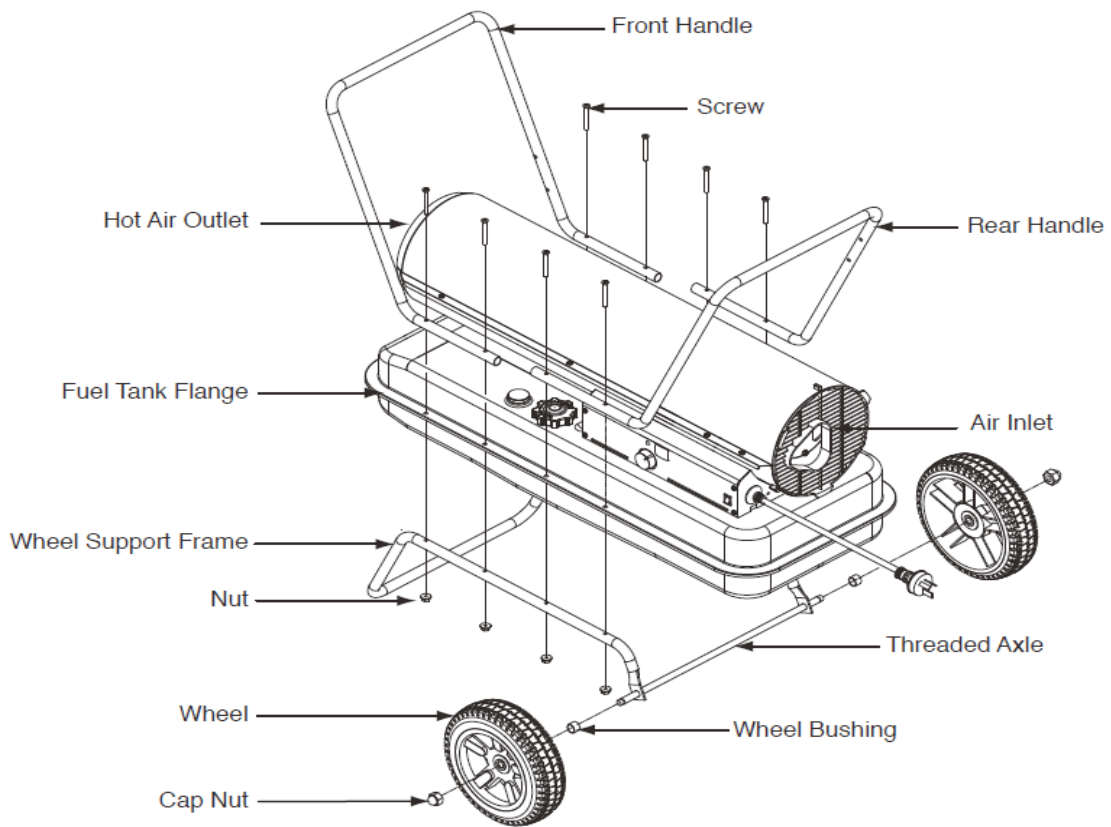

Figure C

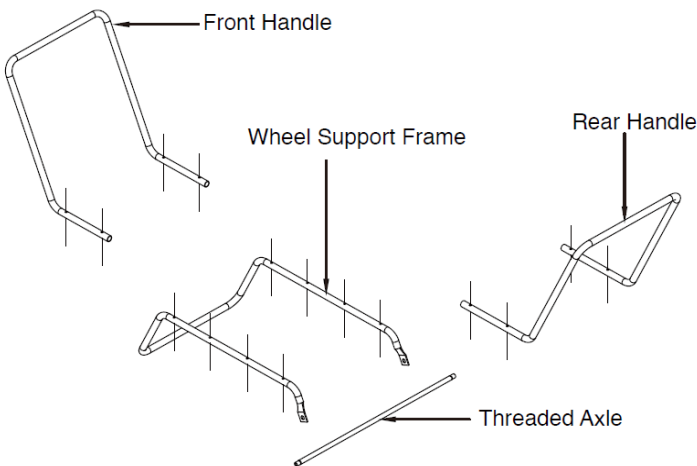
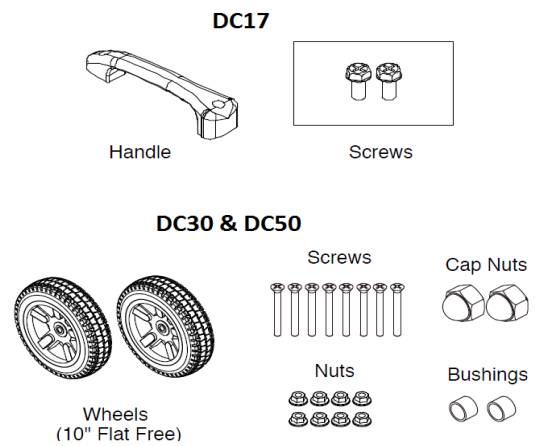

Figure D





ASSEMBLY, INSTALLATION AND OPERATING INSTRUCTIONS

ASSEMBLY

- 1 Identify your unit from the model description on the serial number label affixed to the heater.
- 2 Where necessary (Refer Figure - D), assemble as follows:

For DC17 refer Figure A

- 1 Lift front guard in direction of arrow. Make sure guard's wedged portion fits into the slit hole in the upper shell and faces the hot air outlet.
- 2 Align the holes in the upper shell with the two mounting holes on the handle as shown in Figure A.
- 3 Insert screws into the holes in the handle and tighten each screw.

For DC30 and DC50 models only refer Figure B

- DC30 and DC50 models are fitted with wheels and handles. Wheels, handles and mounting hardware can be located in the shipping carton.
- 1 Slide threaded axle through the rear section of the wheel support frame.
 - 2 Slide one axle bushing onto each side of the axle. Slide one wheel onto each side of the axle. Attach one cap nut onto each side of the threaded axle and tighten.
 - 3 Place heater on wheel support frame. Align the holes on fuel tank flange with holes on wheel support frame.
 - 4 Position handles on top of fuel tank flange. Insert screws through handles, fuel tank flange and wheel support frames as shown in Figure B and hand tighten nut after each screw is inserted.
 - 5 After all screws are inserted, tighten nuts firmly.

OPERATING INSTRUCTIONS

To Start (Normal Operation)

- 1 Fill the tank with filtered fuel.
- 2 Be sure fuel cap is secure.
- 3  Plug power cord into 230V power outlet.
Turn "Thermostat Control Knob" to desired setting (Figure E) (setting range : 5°C~45°C) and push operating switch to "ON" position, power indicator lamp will light and heater will start.

NOTE

-  For DC30 and DC50, DO NOT OPERATE heater without support frame assembled to tank.

To Stop (Normal Operation)

- 1 Turn the Operating Switch to "OFF" position. Combustion will stop.
- 2 Remove the plug from the electrical outlet.

LONG TERM STORAGE

When the heater is not going to be used for a long period it is to be stored in accordance with the steps shown below.

- 1 Drain fuel tank through fuel cap opening. (For DC17 only)
- 2 Remove fuel drain bolt from rear bottom side of fuel tank using 3/4" socket or adjustable wrench and drain. (For DC30 & DC50)
- 4 Using a small amount of kerosene, swirl and rinse the inside of the tank and pour kerosene out.
- 5 Reinstall fuel cap. Properly dispose of old and dirty fuel. (For DC17 Only)
- 6 Reinstall Fuel Drain Bolt to Fuel tank and tighten firmly using 3/4" socket or adjustable wrench. (For DC30 & DC50)
- 7 Store heater in dry well ventilated area. Make sure storage place is free of dust and corrosive fumes.
- 8 Store the heater in the original box with the original packing material



MAINTENANCE INSTRUCTIONS AND TROUBLESHOOTING

MAINTENANCE INSTRUCTIONS

To maintain this unit in peak working condition during its operating life it is necessary to carry out regular maintenance operations and replace worn or broken parts immediately upon their failure. We strongly advise that all maintenance is carried out by an authorized JETFIRE agent using original spare parts.



Failure to follow the maintenance guidelines in this booklet releases the manufacturer from any responsibility in reference to injuries and damages to both persons and goods.



This also may render any warranty given with the unit void.

General

- 1 Power cable (Each use)
 - Check the power cable / plug for any cuts, abrasions or damage before each use. If damage is found it must be replaced immediately (Not repaired) by an authorized service person / electrician.
- 2 Fuel connections (Each use)
 - Check fuel fittings and connections for leaks.
- 3 Performance (Each use)
 - Check machine functionality to ensure it is operating as normal.
 - Check the units performance characteristics as specified in technical data.

Should any issue be found contact an authorized JETFIRE agent immediately for repair.

Note



ALWAYS ISOLATE UNIT FROM THE ELECTRICAL SUPPLY BEFORE ATTEMPTING ANY REPAIRS OR MAINTENANCE.

Replacing Fuel Filter in Fuel Tank. (Figure J)

- 1 Remove side cover screws using screw driver.
- 2 Disconnect switch wires from power switch and remove side cover.
- 3 Pull fuel line off fuel filter neck.
- 4 Turn fuel filter 90° counter clockwise and pull to remove.
(DC17 model only)
- 5 Turn fuel filter 90° clockwise and pull to remove
(DC30 & DC50 only)
- 6 Wash fuel filter with clean fuel and replace in tank.
- 7 Attach fuel line to fuel filter neck.
- 8 Replace switch wires to power switch.
- 9 Reinstall side cover.

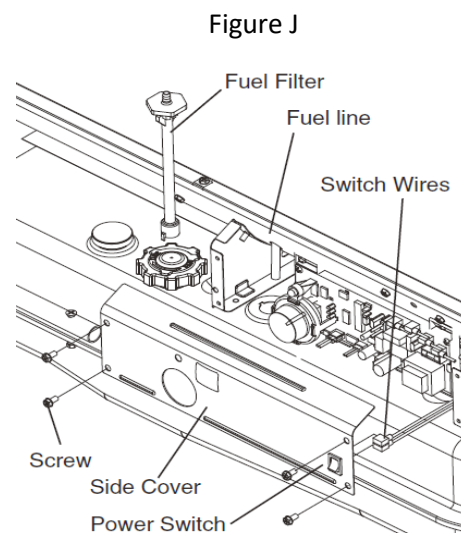

MAINTENANCE SUMMARY

The table below shows the regular maintenance required for your heater, the maintenance interval and which maintenance can be done by the owner.

Interval	Maintenance Required	Done By
Every 150 Hrs	Wash the pump filter in kerosene or diesel.	Owner
Every 150 Hrs	Check that all fuel lines are tight and in good condition.	Owner
Every 200 Hrs	Drain the fuel tank and flush using clean fuel.	Owner
Yearly	Clean the fan blades	Service Agent
Yearly	Clean or replace the nozzle	Service Agent
Yearly	Clean photoelectric tube.	Service Agent
Every 600 Hours	Clean and adjust ignition plug gap	Service Agent

Note

- Time interval for checks and replacement listed above are for units subject to normal operating conditions. Should unit be subject to abnormal conditions (i.e. heavy use or extreme conditions) times should be reduced accordingly.
- Should unit be subject to very limited use, all checks and if necessary replacements should be carried out at least once per year.

TROUBLESHOOTING		
FAULT	CAUSE	REMEDY
The fan motor never starts.	Electrical supply is faulty. Thermostat is incorrect.	Check the power plug is plugged in. Check thermostat setting and connections.
E1	Photocell Fuel tank empty. Photocell not working. Abnormal combustion. Ignition failure.	Fill fuel tank. Contact service agent. Replace bad fuel / Clean filters. Contact service agent.
E2	Room Temperature Sensor Sensor failure.	Contact service agent.
E3	Thermostat Switch Switch failure	Contact service agent.