

ORIGINAL INSTRUCTIONS

OPERATING & MAINTENANCE MANUAL



SPACE HEATERS

J20A, J45A

LPG Industrial Portable Heaters & Dryers

Not for Domestic Use - Space Heating Only

Made in Italy for:

Spitwater Australia Pty Ltd T/A Ottico Equipment

953 Metry Street, Albury NSW 2640 Australia

spitwater.com.au



CREATORS OF



This Heater is approved for industrial use only



WARNING: Read and understand this instruction manual before operating this unit and retain for future reference. Failure to follow operating, safety and maintenance instructions outlined in this manual releases the manufacturer from any responsibility for any accidents or damage incurred and may render any warranty void.

INTRODUCTION

Spitwater Australia is proudly Australian owned and operated since 1982. Our promise is to provide our customers with superior quality portable industrial heaters built to the highest of standards that will see many years of reliable service.

The JETFIRE range of portable industrial heaters are designed to give safe, efficient and reliable service when the correct operating and safety instructions are followed, and proper attention is given to all required maintenance procedures in order to maintain the unit in peak operating condition.

This manual provides the up-to-date information necessary for the user to operate the unit and carry out regular inspection and maintenance.

Please note that the information given within this manual may be subject to revision in compliance with Spitwater Australia's policy of continual improvement.

The JETFIRE range of heaters should only be used in the manner and purpose for which they were intended

and in accordance with the recommendations and safety precautions detailed in this manual and in operating instructions and stickers on the unit itself.

All JETFIRE heaters undergo rigorous safety and operational tests before being dispatched into the marketplace however it is still imperative that prior to used, all operators have read and understood all information and instructions provided and are aware of possible hazards.

GENERAL DESCRIPTION & INTENDED USE

JETFIRE Heaters are specifically designed to solve all problems relating to heating drying and desiccating in commercial and industrial applications. Some examples of applications are in warehouse and factory heating, animal husbandry and greenhouse applications.



SPARE PARTS, ACCESSORIES & SERVICE

Spitwater has an extensive range of spare parts and accessories to suit all your heating needs. For spare parts, accessories and service please refer to the contact section on www.spitwater.com.au or contact **1800 SPITWATER (1800 774 892)**.



TECHNICAL DATA				
	MODEL	J20A	J45A	
	PRODUCT CODE	JGDA020I	JGDA045I	UNIT
PERFORMANCE				
	HEAT OUTPUT	17.92	36.11	kW
	FUEL PRESSURE – REGULATOR	70max/30min	150max/40min	kPa
	FUEL PRESSURE – BURNER	70max/30min	150max/40min	kPa
	NOMINAL GAS CONSUMPTION	65	130	MJ/h
	MINIMUM ROOM VOLUME	350	850	M ³
FUEL				
	FUEL TYPE	Universal LPG	Universal LPG	
	GAS CYLINDER SIZE	45	45	Kg
	NOZZLE / INJECTOR SIZE	1.1	1.2	mm
ELECTRICAL				
	ELECTRICAL SUPPLY	230/1/50	230/1/50	V/~ /Hz
	CONNECTED LOAD	90	240	W
	IGNITION TYPE	AUTOMATIC	AUTOMATIC	
DIMENSIONS, WEIGHT AND OTHER				
	LENGTH	455/505	700	mm
	WIDTH	277	317	mm
	HEIGHT	500	538	mm
	WEIGHT	9.5	16	Kg
	MIN. DISTANCE TO COMBUSTIBLE MATERIAL	3	3	m
The manufacturer reserves the right to modify designs, features and technical data without notice.				

DESCRIPTION OF SYMBOLS

The following symbols are used throughout this instruction booklet in order to mark important paragraphs or sections that are due particular attention. Their meaning is listed next to them for your attention.

	WARNING Failure to follow instruction could result in injury or death		WARNING Failure to follow instruction could result in damage to machine		These are tips and instructions to ensure safe and proper operation
---	---	---	---	---	---

The following symbols are used on the machine in order to warn user of potential injury if not cautious. Their meaning is listed next to them for your attention.

	WARNING Hot surface Do not touch, will result in injury		WARNING Electric shock Disconnect power before removing cover
---	--	---	--

	<p><u>IMPORTANT SAFETY INSTRUCTIONS AND PRECAUTIONS</u></p> <p>WARNING: This heater shall only be used by persons instructed in its use and who have been authorized to do so. Before using this heater please pay attention to the following safety warnings as failure to do so could result in serious injury or even death.</p>
--	--

SAFETY LABELS

 *Always pay attention to the safety instructions provided on each label. Do not alter or remove safety labels*

UNIT COMPONENTS, FEATURES AND CONTROLS

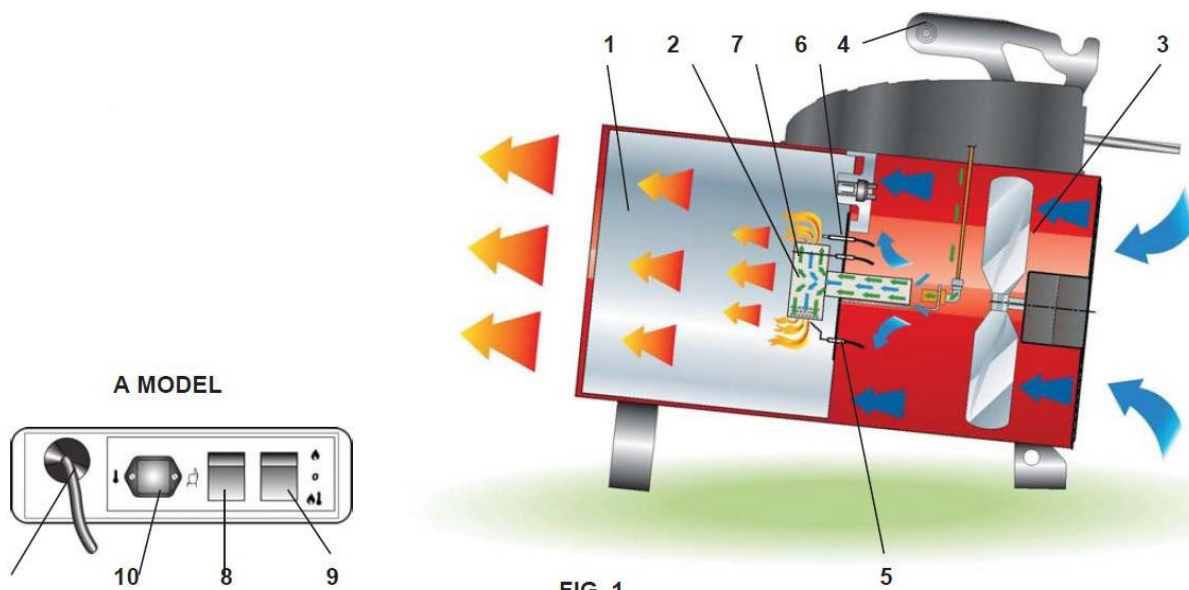

FIG. 1

11

- | | |
|--|---|
| <p>1 COMBUSTION CHAMBER</p> <p>2 BURNER</p> <p>3 COOLING FAN</p> <p>4 HANDLE</p> <p>5 IGNITION ELECTRODE</p> <p>6 THERMOCOUPLE (M model)</p> | <p>7 IONISATION ELECTRODE (A model)</p> <p>8 RESET BUTTON</p> <p>9 HEATING SWITCH</p> <p>10 ROOM THERMOSTAT PLUG</p> <p>11 POWER CORD</p> |
|--|---|

IMPORTANT SAFETY INSTRUCTIONS AND PRECAUTIONS



GENERAL

- This heater must only be operated by persons instructed in its use who have been especially authorized to do so.
- THIS HEATER IS APPROVED FOR INDUSTRIAL USE ONLY.
- NOT FOR DOMESTIC USE. Space heating only.
- DO NOT SPRAY AEROSOLS IN THE VICINITY OF THIS APPLIANCE WHILST IN OPERATION
- DO NOT USE OR STORE FLAMMABLE MATERIALS IN OR NEAR THIS APPLIANCE
- DO NOT MODIFY THIS APPLIANCE
- DO NOT PLACE ARTICLES ON OR AGAINST THIS APPLIANCE
- USE IN A WELL-VENTILATED SPACE.
- Do not operate the heater if it is damaged.
- This heater must be positioned and operated on flat stable ground, not exposed to the elements (rain, hail etc.) and must be operated in an upright position.
- Never leave the heater unattended while operating.
- Make sure you have read and understood the whole instruction manual before installing, operating or carrying out any maintenance on the unit.
- Warnings and data plates on the unit provide important directions and information on the safe use of the unit.



- In addition to these operating and safety instructions, all accident prevention regulations as well as any standards relating to the installation and operation of heaters applicable in your country must be strictly followed.
- This unit is not intended for use by children. Children must always be supervised when in the vicinity and ensure that they DO NOT play with the unit. Further, it is not intended for use by persons with reduced physical, sensory or mental capabilities, or lack of experience or knowledge.
- The heater is not to be installed in an area where there is a risk of fire or explosions;
- Never operate this heater in basements or below ground level because of gas stagnation.
- Do not use the heater on floors made with flammable materials.
- Do not store flammable materials in the vicinity of the heater (minimum distance: 3m);
- Ensure no overheating of walls, or ceilings made of flammable materials,
- Ensure all precautions have been taken to prevent fires;
- Ensure the premises in which the heater is installed are sufficiently ventilated for the burner requirements; in particular, limits regarding air quality in the room to be heated must conform to applicable laws;
- Ensure nothing is obstructing the aspiration and expulsion of air; movement of air may be obstructed in various ways including placing covers or other objects on the heater or positioning the heater too near a wall or other large object;
- Never direct the hot air flow from the heater towards the gas cylinder
- Ensure the heater is regularly monitored during operation and checked before being started;
- Ensure at the beginning of each use, a check is made that the fan moves freely before plugging the heater into the electrical power supply;
- Ensure at the end of each use, the mains switch is disengaged and supply power cord removed, main gas stopcock is closed and gas tube disengaged and sealed.

1. GENERAL ADVICE

The heater must be installed, set up and used in accordance with the applicable regulations and laws relating to the use of such equipment. Minimum distance from surrounding walls and/or ceiling: 2m.



2. ELECTRICAL CONNECTION

- The voltage, hertz rating and number of phases on the data plate must correspond to that of the electrical mains outlet that the unit is being connected to.
- Only connect the unit to electrical installations made by **certified electricians and in keeping with local electrical regulations and requirements.**
- It is recommended that the electrical supply to this unit should include either a residual current device that will interrupt the supply if the leakage current to earth **exceeds 30mA for 30 ms** or a device that will prove the earth circuit.
- This Class 1 Appliance must only be connected to an earthed power supply fitted with an appropriately sized fuse.
- The heater may be connected to a room thermostat by connecting to the thermostat plug (10). Other accessories such as a timer may also be connected.

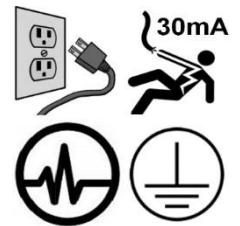

3. POWER CORD

- Make sure before every use that the power cord assembly is not damaged or cut. If it is DO NOT connect the unit,



have it replaced by an electrician or authorized service technician. **(Type Y attachment)**

- DO NOT pull on the power cord in order to unplug the unit, remove the plug from the power outlet.



5. EXTENSION CORD

- If using an extension cord, make sure it is a maximum length of 10 meters and sized according to cross section requirements as shown to the right.
- Inadequate extension cords can be dangerous. If an extension cord is used, it must be suitable for outdoor use and the connection must be kept dry and off ground.
- Make sure the extension cord is fully unrolled, kept dry, away from traffic, sharp edges and heat to avoid damage or cuts.
- If using an extension cord, make sure it is not connected to mains voltage when connecting / disconnecting to the unit's power cord.

LENGTH	
0-10m	
<10A	1.5mm ²
<15A	2.5mm ²
<25A	4.0mm ²



5. TRIP HAZARD

- Loose extension cords and power cables provide a potential trip hazard, especially when they cross pathways.
- Take safety measures like placing traffic cones along the cord or tape the cord to the floor with duct tape.



6. FIRE PREVENTION AND HOT SURFACE CAUTION

- Use only in areas free from flammable materials (flammable vapors, high dust concentrations etc.)
- Keep combustible materials a safe distance from this unit (minimum 3m)
- An external guard should be placed 1m away from the heater outlet to prevent the approach of combustible material.
- Make sure firefighting equipment is readily available
- To avoid burns, be cautious of hot components like the chimney or the Hot Air outlet and its vicinity.
- Do not under any circumstances restrict the air inlet or outlet of the unit. Always allow a clearance of 3m in front (air outlet), 1 m above and behind (air inlet) and 600mm on the sides.
- Do not operate this heater with the top cover removed.



7. EXHAUST & FLUE GASES

- Unit exhaust fumes (which contain carbon monoxide) can lead to death if allowed to build up. Make sure the unit is operated in an area where permanent ventilation to the outside atmosphere is provided. Mandatory minimum room size: 350 Meters Squared (M3)
- Allow a minimum room size as listed in the technical specifications.
- Ensure that any exhaust emissions are not in the vicinity of air intakes.

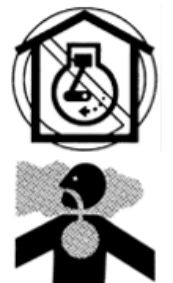

8. FUEL AND LUBRICANTS

- DO NOT smoke or allow flames or sparks in your work area. LPG is extremely flammable and explosive under certain conditions.

9. TRANSPORT

- Disconnect the unit from the power supply and allow it to cool off before moving between work areas.
- Always use the handle to lift and move the unit.
- If transporting the unit make sure it is appropriately strapped to avoid hazards.

10. MAINTENANCE AND SERVICE

- The heater must be checked that it is safe and in proper working order before putting into service and before every use. If the unit is damaged do not use it.
- Always disconnect the unit from the power supply and allow it to cool off before carrying out any inspection, service task or disassembling any part of the heater.
- Never carry out any maintenance work not expressly outlined in this booklet and never make any modifications to this unit.
- Never tamper with any settings of the unit (sealed or unsealed) and make sure that a Spitwater authorized service agent carries out all servicing as required as this usually include checking the correct functioning and setting of all safety devices as well as the correct combustion of the unit.
- Always use original Spitwater spare parts when parts replacements are required.
- Inspect the unit each day before use. Follow “Daily inspection check list” guide *Table-B* in the Maintenance section.
- Service the unit regularly based on its usage. Follow “Usage vs Service frequency” Table (*Table-A*) in the MAINTENANCE section. Always use a Spitwater authorized service agent where requested to.
- Failure to follow the maintenance guidelines in this booklet releases Spitwater from any responsibility in reference to injuries and damages to both persons and goods and may also render any warranty given with the unit void.



ASSEMBLY, INSTALLATION, OPERATING AND STORAGE INSTRUCTIONS

INSTALLATION INSTRUCTIONS

Warning



All of the operations described in this section must be performed by skilled personnel only.

POWER CONNECTIONS

Warning



Never attempt to switch the heater on or off by connecting the room thermostat (or other control devices) to the electrical power line.

Installation and connection of room thermostat are described in the specific instructions enclosed. The electrical diagram in this manual shows only the electrical connection of the accessory to the existing electrical system of the heater.

Warning



Do not connect any air distribution hose: this will cause a severe fire hazard!

CONNECTION TO GAS CYLINDERS

If the heater is run continuously on full output frost might form on the GAS cylinder indicating it is starting to “FREEZE”. This condition is caused by excessive vapour withdrawal and can be overcome by using various sizes of cylinders or multiple cylinder combinations.

To minimise the “FREEZING” effect we suggest the heater be connected to a minimum size and quantity of Gas cylinders as follows:

- **1 X 45KG CYLINDER (Minimum only – increase bottle size/number if using in low temperatures)**

UNDER NO CIRCUMSTANCES SHOULD THE HOT AIR FLOW FROM THE HEATER BE DIRECTED TOWARDS THE GAS CYLINDER TO AVOID THIS “FREEZING.”

Warning



Propane Gas Cylinders must be installed and stored in accordance with current local requirements. Propane Gas Cylinders should always be installed connected and replaced in a flame free atmosphere. Use Propane vapour off-take cylinders only.

Warning



All connections have left-hand threads, and must therefore be tightened by turning anticlockwise.

The heater is supplied complete with gas hose (a) and pressure reducer (c) with fittings (d) for connection to the gas cylinder. The connection supplied is AU ¼” BSP flare male inlet connection.

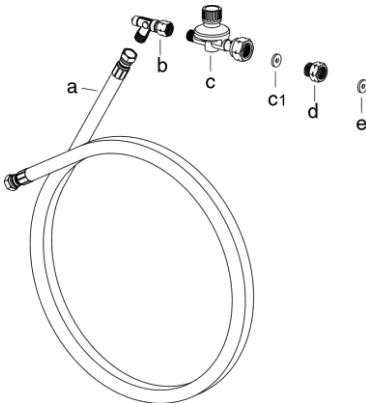

Warning



The installer is responsible for ensuring the correct fitting is used for the connection to the gas cylinder. Always tighten the cylinder fitting first, and then the pressure regulator, which has a swivel fitting.

Warning



The seal of the fittings must be checked by pouring liquid soap on them: the appearance of bubbles indicates a possible gas leak.

Warning



Propane is heavier than air, therefore any gas leakage can cause gas stagnation on the floor or in any underlying room.

A safety valve (b) may be ordered for protection in case of a damaged gas hose. Installation of this valve is mandatory if required by local installation laws and regulations.

Warning



Always make sure that the seal (if required by the fitting) is present between the reducer and the cylinder.

Make sure that the gas hose has been tightened without being twisted: any stress from twisting can seriously damage the hose.

OPERATING INSTRUCTIONS

Warning



Before switching on the heater, check that the power supply specifications are the same as those stated on the identification plate. Do not operate this appliance before leak checking hoses and gas cylinder connection.

START

ALL MODELS

To start the heater:

- Set the pressure regulator to maximum pressure;
- Slowly open the gas stopcock on the gas cylinder;



Warning



In the case of a suspected gas leak, close the gas stopcock immediately, close the gas cylinder valve, switch off the heater and unplug from the electricity supply.

- Make sure the switch (9) is set to “0”;
- Turn on the switch on the main electrical panel;

A MODELS (with or without room thermostat connected)

- Move the heating switch (9):
 - to  position if room thermostat is not connected
 - to  position if room thermostat is connected and set it to a temperature higher than room temperature
 - Automatic starting cycle starts and light (8) flashes rapidly until the flame lights up.
- If the heater still does not function, see TROUBLESHOOTING GUIDE” to identify the cause of the malfunction.

To stop the heater:

To stop operation turn the thermostat adjustment down: the flame goes out and the fan motor stops.

Close the gas supply stopcock and turn off the heating switch.

Warning



If the heater is not used continuously, stop it by first closing the gas supply stopcock and then switch it off or by turning down the thermostat this allows the gas in the gas tube to be fully used and avoids any future leak when removing the gas tube.

Warning



The reset button (8) may have different light types:

- light off: unit is working normally, flame is regular.
- fast flashing: unit is running on starting cycle.
- slow flashing: unit is in stand-by status, waiting for heating request.
- steady light: lock-out status.

TRANSPORTING AND HANDLING

The space heater can be lifted and moved easily by means of its handle. Remove all or any packaging before use.

Warning



Before moving the unit:

- Stop the heater as indicated in the “STOP” paragraph;
- Disconnect the power supply by removing the plug from the power socket;
- Close the gas stopcock and disconnect the gas hose;
- Wait until the heater cools.

Warning



During transportation and/or storage, make sure the gas valve group and gas connection pipes are not knocked or damaged in any way.

Warning



The operations described in this section must only be performed by authorized personnel only.

The following procedures must be carried out at regular intervals to ensure efficient operation of the heater. Ensure heater is disconnected from mains power before starting any work.

The Usage v Maintenance Frequency table below shows the regular maintenance required for your heater, the maintenance interval and which maintenance can be done by the owner.

Interval	Maintenance Required	Done By
Every day	Check heater	Owner
Every day	Check gas supply line	Owner
Every week	Clean exterior of heater	Owner
Every week	Check electrical connections	Owner
Every 6 months	Clean motor & fan	Authorized service Agent
Every year	Clean burner & combustion chamber	Authorized service Agent

Table A



Time interval for checks and replacement listed above are for units subjected to normal operating conditions. Should the unit be subjected to abnormal conditions (eg constant use, extreme temperatures or conditions etc) times should be reduced accordingly.

Warning



Before carrying out any maintenance:

- **Stop the heater as indicated in the “STOP” paragraph;**
- **Switch off the power supply by means of the cut-off on the electrical panel;**
- **Wait until the heater cools.**

1. CHECKING THE HEATER AND THE GAS SUPPLY LINE

Perform the following checks:

- Ensure heater is not installed where there may be a risk of fire or explosion
- Ensure flammable materials are kept a safe distance away
- If you smell gas:
 - Open windows immediately
 - Do not touch electrical switches
 - Close the gas stopcock
 - Find and repair the source of the gas leak
- Do not use the heater if any removed panels have not been remounted
- Ensure room to be heated is sufficiently ventilated

- Ensure the air intake and outlet are completely unobstructed
- Ensure the heater is not covered by any sheets or covers
- Check that the heater is in a fixed and stable position;
- Ensure the heater is constantly monitored during operation and checked before being started;

2. CLEANING THE EXTERIOR OF THE HEATER

To ensure efficient operation, clean the following parts:

- Pipes, connectors and joints:
 - Clean with a cloth.
- External body:
 - Clean with a cloth.
- Air inlet/outlet:
 - Remove all dirt and debris
 - Make sure the air inlet/outlet are not obstructed.

3. CHECKING THE ELECTRICAL CONNECTIONS

After detaching the power cable, check all electrical connections as follows:

- Make sure that all connections are complete and tight.
- If there are traces of dirt or corrosion, contact authorised Spitwater service agent to clean and/or replace the connections as necessary.
- Contact authorised Spitwater service agent replace any damaged wires or connectors if necessary.

4. CLEANING THE MOTOR AND THE FAN (TO BE CARRIED OUT BY AUTHORISED SPITWATER SERVICE AGENT ONLY)

Clean the fan blades and the motor as follows:

- Remove the fastening screws on the fan safety grille.
- Clean the motor with cloth or hard brush
- Clean the fan blades with a hard brush.
- Reinstall the safety grille.
- Close the side inspection panel

5. CLEANING THE COMBUSTION CHAMBER (TO BE CARRIED OUT BY AUTHORISED SPITWATER SERVICE AGENT ONLY)

To maintain the burner's high efficiency and prolong its life, the procedure described in this paragraph must be done at least once at the end of the work season or more frequently if there is an excessive build-up of soot. Excessive soot may be caused by poor chimney draught, poor fuel quality, poor regulation of the burner, or more or less frequent alternation of burner starts and stops. Pay attention during operation: pulsations at start may be due to excessive amounts of soot.

To access the combustion chamber:

- Remove the side inspection panel
- Clean with compressed air or a metal brush
- Reinstall the safety grille.

Warning



After any technical work, always check that the heater works correctly.

Warning



Incorrect cleaning of the heater can cause damage to property and/or people.

SERVICE/CARE RECOMMENDATIONS AND TROUBLESHOOTING GUIDE

To maintain this unit in peak working condition during its operating life it is necessary to carry out regular maintenance operations and replace worn or broken parts immediately upon their failure. The unit should never be operated if damaged. All checks, maintenance and servicing other than procedures expressly outlined and authorized in this booklet are to be carried out by an authorized Spitwater service agent using original spare parts. Ensure all servicing safety precautions are followed and always isolate the unit from the electrical supply before carrying out any maintenance or repairs.

For service please contact **1800 SPITWATER (1800 774 892)** or refer to the contact section on www.spitwater.com.au



Time interval for checks and replacement listed above are for units subjected to normal operating conditions. Should the unit be subjected to abnormal conditions (eg constant use, extreme temperatures or conditions etc) times should reduce accordingly.

OPERATOR INSPECTION AND MAINTENANCE CHECK LIST

Symbols meaning:



Unit is fit, proceed task



Do it yourself refer to our service tips



Do not use the unit. Contact Spitwater authorised service agent immediately

CHECKED AND OK
NEEDS ATTENTION



DAILY PRIOR TO STARTING THE UNIT

Ensure all guards, covers and shields are in place before operating the unit.

Check the power cable for any cuts, abrasions or damage.

Check fuel fittings and lines for leaks.

Check the unit is not damaged.

Check the fan blades rotate freely.

Check that all operator maintenance tasks or servicing has been done according to Table-A

DAILY ON FIRST UNIT RUN



Check proper function of switches and temperature controller



Check color and smell of exhaust fumes. (Dark or smelly fumes= abnormal)

Table B

TROUBLESHOOTING

FAULTS	CAUSES	REMEDIES
<ul style="list-style-type: none"> • The heater fails to start and fan does not start 	<ul style="list-style-type: none"> • No power supply 	<ul style="list-style-type: none"> • Check power specifications • Check power connections • Contact Spitwater service agent
	<ul style="list-style-type: none"> • Mains switch in wrong position 	<ul style="list-style-type: none"> • Select correct position
	<ul style="list-style-type: none"> • Faulty operation of room thermostat (A model) 	<ul style="list-style-type: none"> • Check thermostat position • Check thermostat electrical connection • Contact Spitwater service agent
<ul style="list-style-type: none"> • The heater fails to start flame and stops while: A MODEL >> lamp lights up with steady red light 	<ul style="list-style-type: none"> • Insufficient gas supply 	<ul style="list-style-type: none"> • Check if gas bottle is empty • Check gas supply line and remove any debris inside • Check pressure regulator and replace if necessary
	<ul style="list-style-type: none"> • Safety thermostat tripped due to overheating of combustion chamber 	<ul style="list-style-type: none"> • Check that the suction and the flow grills are unobstructed • Check that the room is well ventilated • Check that hot air can escape freely • Contact Spitwater service agent
	<ul style="list-style-type: none"> • The flame does not light up 	<ul style="list-style-type: none"> • Check that the suction and the flow grills are unobstructed • Contact Spitwater service agent
	<ul style="list-style-type: none"> • Faulty safety thermostat 	<ul style="list-style-type: none"> • Check room thermostat and replace it if necessary • Contact Spitwater service agent
	<ul style="list-style-type: none"> • Ionization electrode does not detect a flame (A model) 	<ul style="list-style-type: none"> • Contact Spitwater service agent
	<ul style="list-style-type: none"> • Control unit tripped due to irregular burner operation (A model) 	<ul style="list-style-type: none"> • Contact Spitwater service agent
	<ul style="list-style-type: none"> • Faulty electronic control unit (A model) 	<ul style="list-style-type: none"> • Contact Spitwater service agent
	<ul style="list-style-type: none"> • Gas solenoid valve does not close because of debris 	<ul style="list-style-type: none"> • Close main gas stopcock on gas bottle, let the heater burn remaining gas in gas tube, and contact Spitwater service agent
<ul style="list-style-type: none"> • The heater does not stop when "STOP" procedure is followed 	<ul style="list-style-type: none"> • Faulty room thermostat (A model) 	<ul style="list-style-type: none"> • Check room thermostat and replace it if necessary • Check electric connection of room thermostat • Contact Spitwater service agent
	<ul style="list-style-type: none"> • Fan noise or vibrations 	<ul style="list-style-type: none"> • Foreign bodies on fan blades
	<ul style="list-style-type: none"> • Insufficient air circulation 	<ul style="list-style-type: none"> • Eliminate all possible obstacles to proper air flow

SAFETY DEVICES

Space heaters are direct-combustion and forced convection units. Air is heated by the thermal energy generated during combustion and is then conveyed to the room to be heated along with the combustion products: the room **MUST** be suitably ventilated to ensure adequate air circulation. Various safety devices trip in the event of serious malfunction:

Temperature Limit Control:

This heater is equipped with a Temperature Limit Control / overheating thermostat LI designed to turn off the heater should the internal temperature rise to an unsafe level. If this device activates and turns the heater off, it may require service.

Electrical System Protection:

The heater's electrical system is protected by a fuse mounted to the PCB assembly that protects the system components from damage. If the heater fails, check the fuse first, replace if necessary.

Flame-Out Sensor:

The electronic burner control unit trips if the flame is irregular or goes out: in Automatic heater models the reset button (8) lights up with a steady red light.

In each of the cases described above, the space heater stops working in lock-out condition. The cause of the malfunction must always be investigated and eliminated before starting the heater again. Refer to 'TROUBLESHOOTING' guide contained within this manual for advice and if in any doubt, contact your authorized Spitwater service agent. Note the heater can restart only if reset button (8) is pressed (red lamp is off).

Wiring Diagram

C Capacitor

MV Fan motor

FUA Fuse

RV Switch

PR Reset switch

LI Overheat safety thermostat

AP Control box

TA Room thermostat plug

EV Gas solenoid valve

RP Resistance

PA Air pressure switch

EL Ionisation electrode

